

Data sheet | Item number: 769-229/281-413

2-pin component carrier block; LED (red); 24 VDC; for DIN-rail 35 x 15 and 35 x 7.5

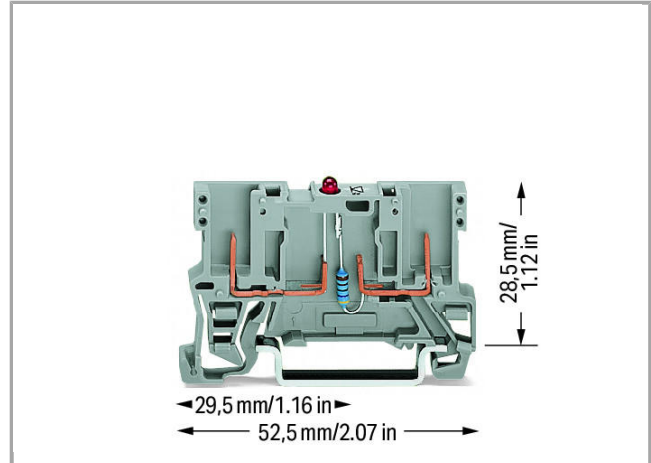

769-229/281-413

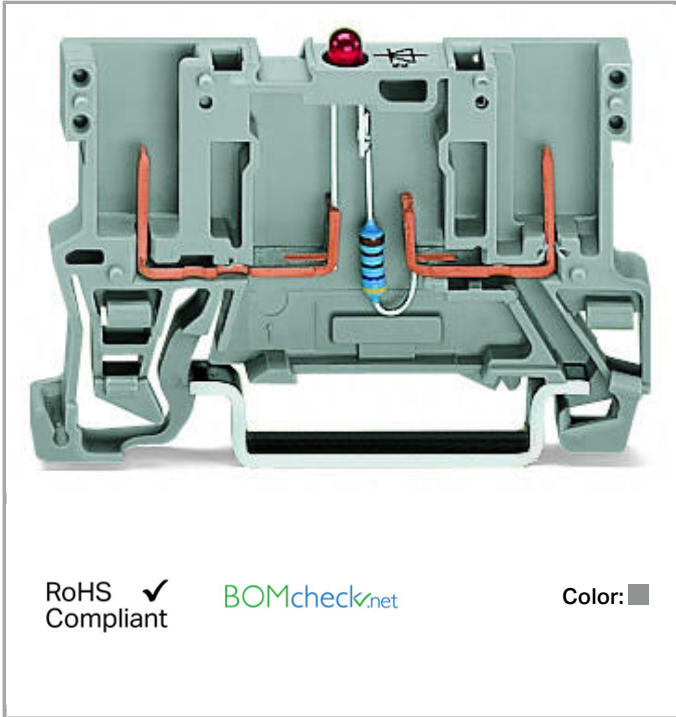

RoHS Compliant

[BOMcheck.net](https://www.bomcheck.net)

Color:

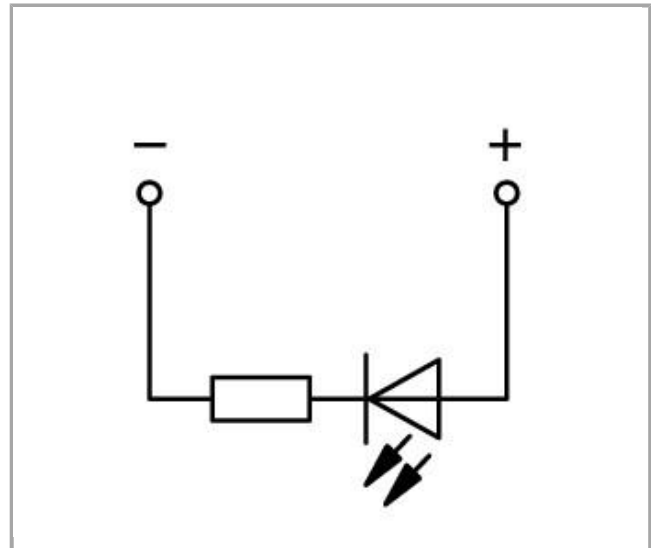
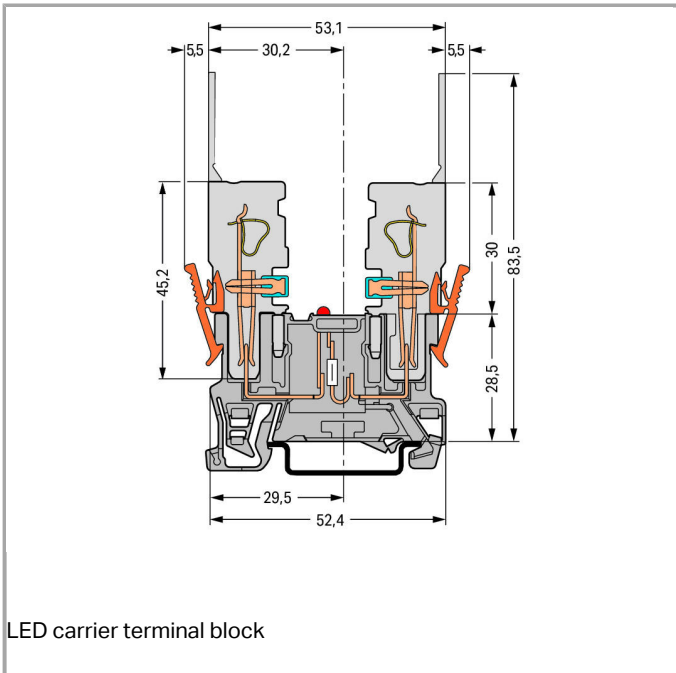

LED carrier terminal block

Data
Electrical data



Voltage type (1)	DC
Nominal voltage	24 V

Ratings per IEC/EN 60664-1

Rated current	0.025 A
---------------	---------

Connection data

Total number of potentials	1
Number of levels	1
Type of wiring	Front-entry wiring

Geometrical Data

Width	5 mm / 0.197 inch
Height from upper-edge of DIN-35 rail	28.5 mm / 1.122 inch
Depth	52.5 mm / 2.067 inch

Mechanical data

Design	horizontal
Type of mounting	DIN-35 rail
Marking level	Center marking

Material Data

Color	gray
Insulating material	Polyamide 66 (PA 66)
Fire load	0.096 MJ
Weight	4.7 g

Commercial data

Product Group	18 (X-COM-System)
Country of origin	DE
GTIN	4045454619473
Customs Tariff No.	85369010000

Approvals / Certificates

Country specific Approvals

Logo	Approval	Additional Approval Text	Certificate name
	CCA DEKRA Certification B.V.	EN 60947	NTR NL- 7626

CCA



CSA
DEKRA Certification B.V.

C22.2 No. 158

1101144



KEMA/KEUR
DEKRA Certification B.V.

EN 60947





2190419.01

Ship Approvals

Logo	Approval	Additional Approval Text	Certificate name
	<p>ABS American Bureau of Shipping</p>	EN 60947	14-HG1293677-PDA

Compatible products















Jumper















	<p>Item no.: 249-123 Push-in type wire jumper; insulated; wire length 180 mm; Conductor cross section 0.75 mm²</p>	249-123
	<p>Item no.: 249-125 Push-in type wire jumper; insulated; wire length 60 mm; Conductor cross section 0.75 mm²</p>	249-125
	<p>Item no.: 249-126 Push-in type wire jumper; insulated; wire length 110 mm; Conductor cross section 0.75 mm²</p>	249-126
	<p>Item no.: 249-127 Push-in type wire jumper; insulated; wire length 250 mm; Conductor cross section 0.75 mm²</p>	249-127















check















	<p>Item no.: 210-137 Test plug; 2.3 mm Ø; with 500 mm cable</p>	210-137
--	---	---------















Female plug















	Item no.: 769-101 1-conductor female plug; 4 mm ² ; 1-pole		769-101
	Item no.: 769-101/000-006 1-conductor female plug; 4 mm ² ; 1-pole	/000-006	769-101
	Item no.: 769-101/000-016 1-conductor female plug; 4 mm ² ; 1-pole	/000-016	769-101
	Item no.: 769-101/022-000 1-conductor female plug; angled; 4 mm ² ; 1-pole	/022-000	769-101
	Item no.: 769-101/022-016 1-conductor female plug; angled; 4 mm ² ; 1-pole	/022-016	769-101
	Item no.: 769-102 1-conductor female plug; 4 mm ² ; 2-pole		769-102
	Item no.: 769-102/000-006 1-conductor female plug; 4 mm ² ; 2-pole	/000-006	769-102
	Item no.: 769-102/000-036 1-conductor female plug; 4 mm ² ; 2-pole	/000-036	769-102
	Item no.: 769-102/000-037 1-conductor female plug; 4 mm ² ; 2-pole	/000-037	769-102
	Item no.: 769-102/022-000 1-conductor female plug; angled; 4 mm ² ; 2-pole	/022-000	769-102
	Item no.: 769-103 1-conductor female plug; 4 mm ² ; 3-pole		769-103
	Item no.: 769-103/000-006 1-conductor female plug; 4 mm ² ; 3-pole	/000-006	769-103
	Item no.: 769-103/000-036 1-conductor female plug; 4 mm ² ; 3-pole	/000-036	769-103
	Item no.: 769-103/000-037 1-conductor female plug; 4 mm ² ; 3-pole	/000-037	769-103
	Item no.: 769-103/000-038 1-conductor female plug; 4 mm ² ; 3-pole	/000-038	769-103

















	Item no.: 769-103/000-039 1-conductor female plug; 4 mm ² ; 3-pole		769-103 /000-039
	Item no.: 769-103/022-000 1-conductor female plug; angled; 4 mm ² ; 3-pole		769-103 /022-000
	Item no.: 769-104 1-conductor female plug; 4 mm ² ; 4-pole		769-104
	Item no.: 769-104/000-006 1-conductor female plug; 4 mm ² ; 4-pole		769-104 /000-006
	Item no.: 769-104/000-036 1-conductor female plug; 4 mm ² ; 4-pole		769-104 /000-036
	Item no.: 769-104/000-037 1-conductor female plug; 4 mm ² ; 4-pole		769-104 /000-037
	Item no.: 769-104/000-038 1-conductor female plug; 4 mm ² ; 4-pole		769-104 /000-038
	Item no.: 769-104/000-039 1-conductor female plug; 4 mm ² ; 4-pole		769-104 /000-039
	Item no.: 769-104/022-000 1-conductor female plug; angled; 4 mm ² ; 4-pole		769-104 /022-000
	Item no.: 769-105 1-conductor female plug; 4 mm ² ; 5-pole		769-105
	Item no.: 769-105/000-006 1-conductor female plug; 4 mm ² ; 5-pole		769-105 /000-006
	Item no.: 769-105/000-036 1-conductor female plug; 4 mm ² ; 5-pole		769-105 /000-036
	Item no.: 769-105/000-037 1-conductor female plug; 4 mm ² ; 5-pole		769-105 /000-037
	Item no.: 769-105/000-038 1-conductor female plug; 4 mm ² ; 5-pole		769-105 /000-038
	Item no.: 769-105/000-039 1-conductor female plug; 4 mm ² ; 5-pole		769-105 /000-039

	Item no.: 769-105/022-000 1-conductor female plug; angled; 4 mm ² ; 5-pole	769-105 /022-000
	Item no.: 769-106 1-conductor female plug; 4 mm ² ; 6-pole	769-106
	Item no.: 769-106/000-006 1-conductor female plug; 4 mm ² ; 6-pole	769-106 /000-006
	Item no.: 769-106/000-036 1-conductor female plug; 4 mm ² ; 6-pole	769-106 /000-036
	Item no.: 769-106/000-037 1-conductor female plug; 4 mm ² ; 6-pole	769-106 /000-037
	Item no.: 769-106/000-038 1-conductor female plug; 4 mm ² ; 6-pole	769-106 /000-038
	Item no.: 769-106/000-039 1-conductor female plug; 4 mm ² ; 6-pole	769-106 /000-039
	Item no.: 769-106/022-000 1-conductor female plug; angled; 4 mm ² ; 6-pole	769-106 /022-000
	Item no.: 769-107 1-conductor female plug; 4 mm ² ; 7-pole	769-107
	Item no.: 769-107/000-006 1-conductor female plug; 4 mm ² ; 7-pole	769-107 /000-006
	Item no.: 769-107/000-036 1-conductor female plug; 4 mm ² ; 7-pole	769-107 /000-036
	Item no.: 769-107/000-037 1-conductor female plug; 4 mm ² ; 7-pole	769-107 /000-037
	Item no.: 769-107/000-038 1-conductor female plug; 4 mm ² ; 7-pole	769-107 /000-038
	Item no.: 769-107/000-039 1-conductor female plug; 4 mm ² ; 7-pole	769-107 /000-039
	Item no.: 769-107/022-000 1-conductor female plug; angled; 4 mm ² ; 7-pole	769-107 /022-000
	Item no.: 769-108	

	1-conductor female plug; 4 mm ² ; 8-pole		769-108
	Item no.: 769-108/000-006 1-conductor female plug; 4 mm ² ; 8-pole	/000-006	769-108
	Item no.: 769-108/000-036 1-conductor female plug; 4 mm ² ; 8-pole	/000-036	769-108
	Item no.: 769-108/000-037 1-conductor female plug; 4 mm ² ; 8-pole	/000-037	769-108
	Item no.: 769-108/000-038 1-conductor female plug; 4 mm ² ; 8-pole	/000-038	769-108
	Item no.: 769-108/000-039 1-conductor female plug; 4 mm ² ; 8-pole	/000-039	769-108
	Item no.: 769-108/022-000 1-conductor female plug; angled; 4 mm ² ; 8-pole	/022-000	769-108
	Item no.: 769-109 1-conductor female plug; 4 mm ² ; 9-pole		769-109
	Item no.: 769-109/000-006 1-conductor female plug; 4 mm ² ; 9-pole	/000-006	769-109
	Item no.: 769-109/000-036 1-conductor female plug; 4 mm ² ; 9-pole	/000-036	769-109
	Item no.: 769-109/000-037 1-conductor female plug; 4 mm ² ; 9-pole	/000-037	769-109
	Item no.: 769-109/000-038 1-conductor female plug; 4 mm ² ; 9-pole	/000-038	769-109
	Item no.: 769-109/000-039 1-conductor female plug; 4 mm ² ; 9-pole	/000-039	769-109
	Item no.: 769-109/022-000 1-conductor female plug; angled; 4 mm ² ; 9-pole	/022-000	769-109
	Item no.: 769-110 1-conductor female plug; 4 mm ² ; 10-pole		769-110

	Item no.: 769-110/000-006 1-conductor female plug; 4 mm ² ; 10-pole		769-110
		/000-006	
	Item no.: 769-110/000-036 1-conductor female plug; 4 mm ² ; 10-pole		769-110
		/000-036	
	Item no.: 769-110/000-037 1-conductor female plug; 4 mm ² ; 10-pole		769-110
		/000-037	
	Item no.: 769-110/000-038 1-conductor female plug; 4 mm ² ; 10-pole		769-110
		/000-038	
	Item no.: 769-110/000-039 1-conductor female plug; 4 mm ² ; 10-pole		769-110
		/000-039	
	Item no.: 769-110/022-000 1-conductor female plug; angled; 4 mm ² ; 10-pole		769-110
		/022-000	
	Item no.: 769-111 1-conductor female plug; 4 mm ² ; 11-pole		769-111
	Item no.: 769-111/000-006 1-conductor female plug; 4 mm ² ; 11-pole		769-111
		/000-006	
	Item no.: 769-111/000-036 1-conductor female plug; 4 mm ² ; 11-pole		769-111
		/000-036	
	Item no.: 769-111/000-037 1-conductor female plug; 4 mm ² ; 11-pole		769-111
		/000-037	
	Item no.: 769-111/000-038 1-conductor female plug; 4 mm ² ; 11-pole		769-111
		/000-038	
	Item no.: 769-111/000-039 1-conductor female plug; 4 mm ² ; 11-pole		769-111
		/000-039	
	Item no.: 769-111/022-000 1-conductor female plug; angled; 4 mm ² ; 11-pole		769-111
		/022-000	
	Item no.: 769-112 1-conductor female plug; 4 mm ² ; 12-pole		769-112
	Item no.: 769-112/000-006 1-conductor female plug; 4 mm ² ; 12-pole		769-112
		/000-006	

	Item no.: 769-112/000-036 1-conductor female plug; 4 mm ² ; 12-pole	/000-036	769-112
	Item no.: 769-112/000-037 1-conductor female plug; 4 mm ² ; 12-pole	/000-037	769-112
	Item no.: 769-112/000-038 1-conductor female plug; 4 mm ² ; 12-pole	/000-038	769-112
	Item no.: 769-112/000-039 1-conductor female plug; 4 mm ² ; 12-pole	/000-039	769-112
	Item no.: 769-112/022-000 1-conductor female plug; angled; 4 mm ² ; 12-pole	/022-000	769-112
	Item no.: 769-113 1-conductor female plug; 4 mm ² ; 13-pole		769-113
	Item no.: 769-113/000-036 1-conductor female plug; 4 mm ² ; 13-pole	/000-036	769-113
	Item no.: 769-113/000-037 1-conductor female plug; 4 mm ² ; 13-pole	/000-037	769-113
	Item no.: 769-113/000-038 1-conductor female plug; 4 mm ² ; 13-pole	/000-038	769-113
	Item no.: 769-113/000-039 1-conductor female plug; 4 mm ² ; 13-pole	/000-039	769-113
	Item no.: 769-113/022-000 1-conductor female plug; angled; 4 mm ² ; 13-pole	/022-000	769-113
	Item no.: 769-114 1-conductor female plug; 4 mm ² ; 14-pole		769-114
	Item no.: 769-114/000-006 1-conductor female plug; 4 mm ² ; 14-pole	/000-006	769-114
	Item no.: 769-114/000-036 1-conductor female plug; 4 mm ² ; 14-pole	/000-036	769-114
	Item no.: 769-114/000-037 1-conductor female plug; 4 mm ² ; 14-pole	/000-037	769-114

	Item no.: 769-114/000-038 1-conductor female plug; 4 mm²; 14-pole		769-114
		7000-038	
	Item no.: 769-114/000-039 1-conductor female plug; 4 mm²; 14-pole		769-114
		7000-039	
	Item no.: 769-114/022-000 1-conductor female plug; angled; 4 mm²; 14-pole		769-114
		7022-000	
	Item no.: 769-115 1-conductor female plug; 4 mm²; 15-pole		769-115
	Item no.: 769-115/000-036 1-conductor female plug; 4 mm²; 15-pole		769-115
		7000-036	
	Item no.: 769-115/000-037 1-conductor female plug; 4 mm²; 15-pole		769-115
		7000-037	
	Item no.: 769-115/000-038 1-conductor female plug; 4 mm²; 15-pole		769-115
		7000-038	
	Item no.: 769-115/000-039 1-conductor female plug; 4 mm²; 15-pole		769-115
		7000-039	
	Item no.: 769-115/022-000 1-conductor female plug; angled; 4 mm²; 15-pole		769-115
		7022-000	
	Item no.: 769-121 2-conductor female connector; 4 mm²; 1-pole		769-121
	Item no.: 769-121/000-016 2-conductor female connector; 4 mm²; 1-pole		769-121
		7000-016	
	Item no.: 769-122 2-conductor female connector; 4 mm²; 2-pole		769-122
	Item no.: 769-123 2-conductor female connector; 4 mm²; 3-pole		769-123
	Item no.: 769-124 2-conductor female connector; 4 mm²; 4-pole		769-124
	Item no.: 769-125 2-conductor female connector; 4 mm²; 5-pole		769-125
	Item no.: 769-126 2-conductor female connector; 4 mm²; 6-pole		769-126
	Item no.: 769-127 2-conductor female connector; 4 mm²; 7-pole		769-127

**Item no.: 769-128**2-conductor female connector; 4 mm²; 8-pole

769-128

Item no.: 769-1292-conductor female connector; 4 mm²; 9-pole

769-129

Item no.: 769-1302-conductor female connector; 4 mm²; 10-pole

769-130

Item no.: 769-1312-conductor female connector; 4 mm²; 11-pole

769-131

Item no.: 769-1322-conductor female connector; 4 mm²; 12-pole

769-132

Item no.: 769-1332-conductor female connector; 4 mm²; 13-pole

769-133

Item no.: 769-1342-conductor female connector; 4 mm²; 14-pole

769-134

Item no.: 769-1352-conductor female connector; 4 mm²; 15-pole

769-135

General accessories**Item no.: 280-418**

Test plug module; modular; suitable for all WAGO 280 and 780 Series rail-mounted terminal blocks with jumper slots in the current bar

280-418

**Item no.: 280-419**

Spacer module; modular; bridging commoned terminal blocks

280-419

**Item no.: 769-438**

Pin cover; with marker slot for miniature WSB

769-438

**Item no.: 769-439**

Pin cover; with marker slot for miniature WSB

769-439

**Item no.: 769-501**Start module for 1-conductor female connector; with integrated end plate; 4 mm²; 1-pole

769-501

**Item no.: 769-501/000-006**Start module for 1-conductor female connector; 4 mm²; 1-pole

769-501

/000-006

**Item no.: 769-501/000-016**Start module for 1-conductor female connector; with integrated end plate; 4 mm²; 1-pole

769-501

/000-016

















**Item no.: 769-502**Center module for 1-conductor female connector; 4 mm²; 1-pole



















769-502

**Item no.: 769-502/000-006**Center module for 1-conductor female connector; 4 mm²; 1-pole

769-502

/000-006

	Item no.: 769-502/000-016 Center module for 1-conductor female connector; 4 mm ² ; 1-pole	/000-016	769-502
	Item no.: 769-503 End module for 1-conductor female connector; 4 mm ² ; 1-pole		769-503
	Item no.: 769-503/000-006 End module for 1-conductor female connector; 4 mm ² ; 1-pole	/000-006	769-503
	Item no.: 769-503/000-016 End module for 1-conductor female connector; 4 mm ² ; 1-pole	/000-016	769-503
	Item no.: 769-504 Start module for 2-conductor female connector; with integrated end plate; 4 mm ² ; 1-pole		769-504
	Item no.: 769-504/000-006 Start module for 2-conductor female connector; with integrated end plate; 4 mm ² ; 1-pole	/000-006	769-504
	Item no.: 769-504/000-016 Start module for 2-conductor female connector; 4 mm ² ; 1-pole	/000-016	769-504
	Item no.: 769-505 Center module for 2-conductor female connector; 4 mm ² ; 1-pole		769-505
	Item no.: 769-505/000-006 Center module for 2-conductor female connector; 4 mm ² ; 1-pole	/000-006	769-505
	Item no.: 769-505/000-016 Center module for 2-conductor female connector; 4 mm ² ; 1-pole	/000-016	769-505
	Item no.: 769-506 End module for 2-conductor female connector; 4 mm ² ; 1-pole		769-506
	Item no.: 769-506/000-006 End module for 2-conductor female connector; 4 mm ² ; 1-pole	/000-006	769-506
	Item no.: 769-506/000-016 End module for 2-conductor female connector; 4 mm ² ; 1-pole	/000-016	769-506
	Item no.: 769-512 Start module for 1-conductor female connector; angled; 4 mm ² ; 1-pole		769-512
	Item no.: 769-512/000-006 Start module for 1-conductor female connector; angled; 4 mm ² ; 1-pole	/000-006	769-512
	Item no.: 769-512/000-016 Start module for 1-conductor female connector; angled; 4 mm ² ; 1-pole	/000-016	769-512

	Item no.: 769-513 Center module for 1-conductor female connector; angled; 4 mm ² ; 1-pole	769-513
	Item no.: 769-513/000-006 1-conductor center module; angled; codable; 1-pole	769-513 /000-006
	Item no.: 769-513/000-016 1-conductor center module; angled; codable; 1-pole	769-513 /000-016
	Item no.: 769-515 1-conductor end module; angled; codable; 1-pole	769-515
	Item no.: 769-515/000-006 1-conductor end module; angled; codable; 1-pole	769-515 /000-006
	Item no.: 769-515/000-016 1-conductor end module; angled; codable; 1-pole	769-515 /000-016
Carrier rail		
	Item no.: 210-112 Steel carrier rail; 35 x 7.5 mm; 1 mm thick; 2 m long; slotted; according to EN 60715; "Hole width 25 mm	210-112
	Item no.: 210-113 Steel carrier rail; 35 x 7.5 mm; 1 mm thick; 2 m long; unslotted; according to EN 60715	210-113
	Item no.: 210-114 Steel carrier rail; 35 x 15 mm; 1.5 mm thick; 2 m long; unslotted; similar to EN 60715	210-114
	Item no.: 210-115 Steel carrier rail; 35 x 7.5 mm; 1 mm thick; 2 m long; slotted; according to EN 60715; "Hole width 18 mm	210-115
	Item no.: 210-118 Steel carrier rail; 35 x 15 mm; 2.3 mm thick; 2 m long; unslotted; according to EN 60715	210-118
	Item no.: 210-196 Aluminum carrier rail; 35 x 8.2 mm; 1.6 mm thick; 2 m long; unslotted; similar to EN 60715	210-196
	Item no.: 210-197 Steel carrier rail; 35 x 15 mm; 1.5 mm thick; 2 m long; slotted; similar to EN 60715	210-197
	Item no.: 210-198 Copper carrier rail; 35 x 15 mm; 2.3 mm thick; 2 m long; unslotted; according to EN 60715	210-198
	Item no.: 210-504 Steel carrier rail; 35 x 7.5 mm; 1 mm thick; 2 m long; slotted; galvanized; according to EN 60715	210-504
	Item no.: 210-505 Steel carrier rail; 35 x 7.5 mm; 1 mm thick; 2 m long; unslotted; galvanized; according to EN 60715	210-505
	Item no.: 210-506 Steel carrier rail; 35 x 15 mm; 1.5 mm thick; 2 m long; unslotted; galvanized; similar to EN 60715	210-506
	Item no.: 210-508 Steel carrier rail; 35 x 15 mm; 1.5 mm thick; 2 m long; slotted; galvanized; similar to EN 60715	210-508

End plate

	Item no.: 769-305 End and intermediate plate; 1.1 mm thick	769-305
	Item no.: 769-306 End and intermediate plate; 1.1 mm thick	769-306











Coding

	Item no.: 769-435 Coding pin; for coding of female plugs; for carrier terminal blocks / male connectors	769-435
--	---	---------

assembling

	Item no.: 209-106 Mounting carrier; for isolated mounting on DIN 35 rails	209-106
--	---	---------

Marking accessories

	Item no.: 2009-145 Mini-WSB Inline; for Smart Printer; on reel; stretchable 5 - 5.2 mm; plain; snap-on type	2009-145
	Item no.: 2009-145/000-002 Mini-WSB Inline; for Smart Printer; on reel; stretchable 5 - 5.2 mm; plain; snap-on type	2009-145 /000-002
	Item no.: 2009-145/000-005 Mini-WSB Inline; for Smart Printer; on reel; stretchable 5 - 5.2 mm; plain; snap-on type	2009-145 /000-005
	Item no.: 2009-145/000-006 Mini-WSB Inline; for Smart Printer; on reel; stretchable 5 - 5.2 mm; plain; snap-on type	2009-145 /000-006
	Item no.: 2009-145/000-007 Mini-WSB Inline; for Smart Printer; on reel; stretchable 5 - 5.2 mm; plain; snap-on type	2009-145 /000-007
	Item no.: 2009-145/000-012 Mini-WSB Inline; for Smart Printer; on reel; stretchable 5 - 5.2 mm; plain; snap-on type	2009-145 /000-012
	Item no.: 2009-145/000-023 Mini-WSB Inline; for smartPRINTER; on reel; stretchable 5 - 5.2 mm; plain; snap-on type	2009-145 /000-023
	Item no.: 2009-145/000-024 Mini-WSB Inline; for Smart Printer; on reel; stretchable 5 - 5.2 mm; plain; snap-on type	2009-145 /000-024
	Item no.: 248-501 Miniature WSB Quick marking system; plain; Marker width 5 mm; 10 strips with 10 markers per card	248-501
	Item no.: 248-501/000-002 Mini-WSB marking card; as card; not stretchable; plain; snap-on type	248-501 /000-002
	Item no.: 248-501/000-005 Mini-WSB marking card; as card; not stretchable; plain; snap-on type	248-501 /000-005



Item no.: 248-501/000-006
Mini-WSB marking card; as card; not stretchable; plain; snap-on type

/000-006

248-501



Item no.: 248-501/000-007
Mini-WSB marking card; as card; not stretchable; plain; snap-on type

/000-007

248-501



Item no.: 248-501/000-012
Mini-WSB marking card; as card; not stretchable; plain; snap-on type

/000-012

248-501



Item no.: 248-501/000-017
Mini-WSB marking card; as card; not stretchable; plain; snap-on type

/000-017

248-501



Item no.: 248-501/000-023
Mini-WSB marking card; as card; not stretchable; plain; snap-on type

/000-023

248-501



Item no.: 248-501/000-024
Mini-WSB marking card; as card; not stretchable; plain; snap-on type

/000-024

248-501

tools



Item no.: 210-720
Operating tool with partially insulated shaft; Type 2, blade (3.5 x 0.5) mm

210-720

Downloads

Documentation

Bid Text

769-229/281-413	doc 24.6 kB	Download
-----------------	----------------	----------

CAD/CAE - Smart Data

CAD data

3D Download 769-229/281-413	URL	Download
-----------------------------	-----	----------

Product family

X-COM

[Learn more about the product family.](#)

[Show all products from the family](#)



Subject to changes.
